

FYH UCIP211-34 bearing units

Bearing No. UCIP211-34

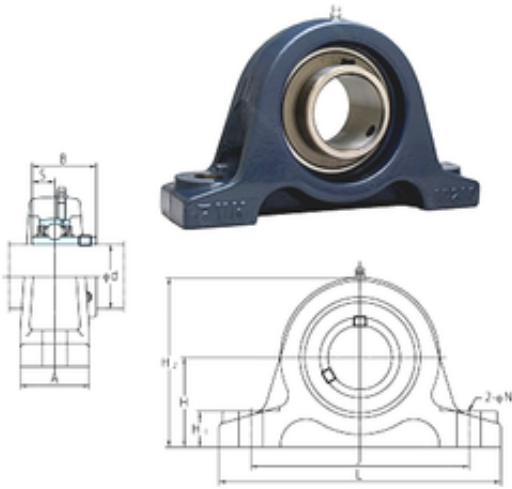

UCIP211-34 Bearing 2D drawings and 3D CAD models

Bore Diameter	53,975 mm
Width	55,6 mm
d	53,975 mm
A	60 mm
B	55,6 mm
H	80 mm
H1	28 mm
H2	148 mm
J	180 mm
L	230 mm
N	19 mm
S	22,2 mm
Bolt (G)	M16
Weight	5,3 Kg
Basic dynamic load rating (C)	43,4 kN
Basic static load rating (C0)	29,4 kN