

**AST H7038AC/HQ1 angular contact ball bearings**

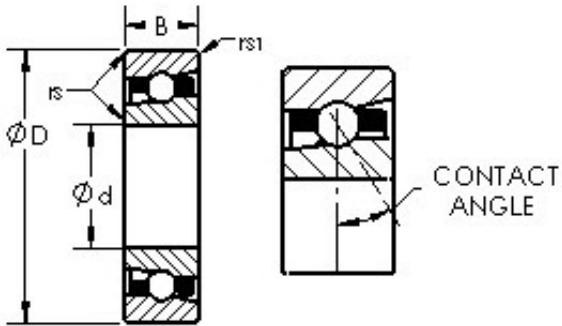

Bearing No. H7038AC/HQ1

Size	190x290x46 mm
Bore Diameter	190 mm
Outer Diameter	290 mm
Width	46 mm
Bearing Type	25 deg contact, high speed
Bore Dia (d)	190.0000
Outer Dia (D)	290.0000
Width (B)	46.0000
Radius (min) (rs)	2.100
Dynamic Load Rating (Cr)	89,700
Static Load Rating (Cor)	117,900
Max Speed (Grease) (X1000 RPM)	5
Max Speed (Oil) (X1000 RPM)	7
Radius (min) (rs1)	1.100
Material	52100 Chrome steel (or equivalent)

H7038AC/HQ1 Bearing 2D drawings and 3D CAD models